

# Su-33

**EX 781**

for kit **MINIBASE**

scale **1/48**

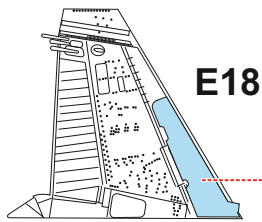
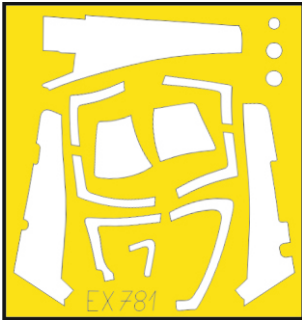

**E18**

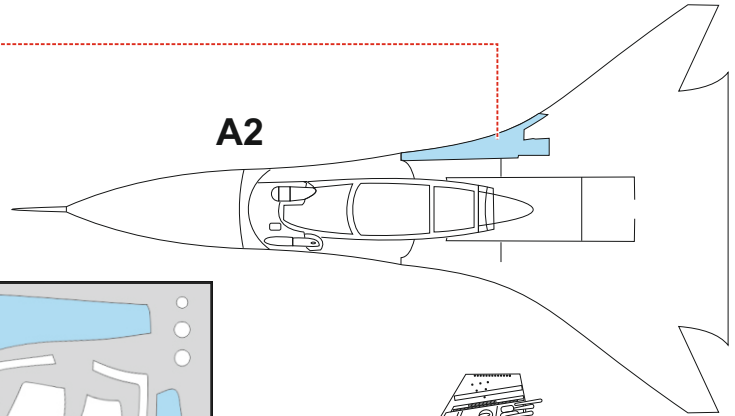
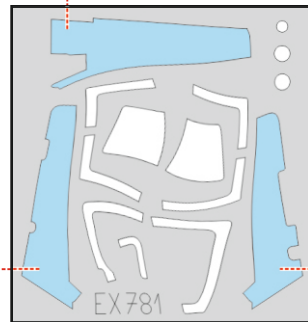

**A2**

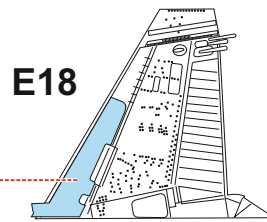

**E18**

**I10**



EX781

**I7**

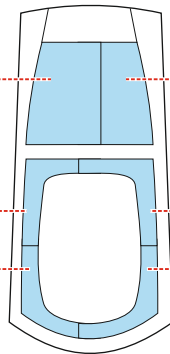

**I8**

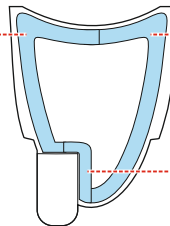

**I11**

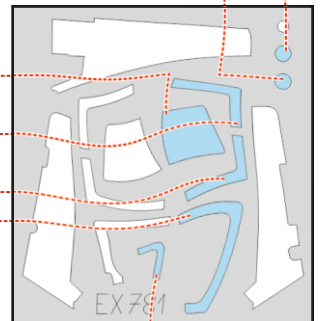

EX781

## LIQUID MASK

