

eduard  
MASK

# P-61 Black Widow 1/72

The die-cut mask for accurate canopy frame painting of the  
*Dragon* scale 1/72 KIT

CX 072

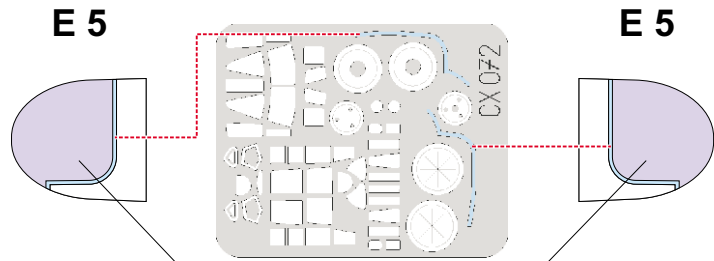
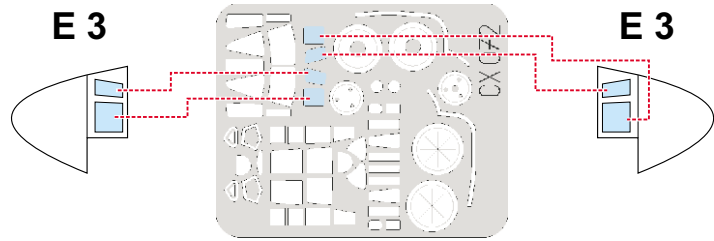
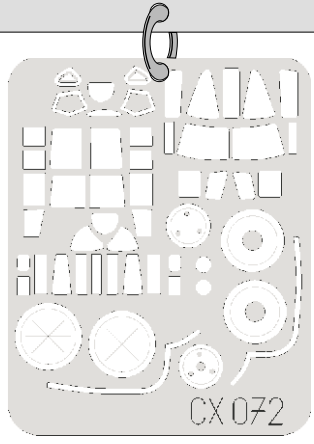

LIQUID MASK

1.)

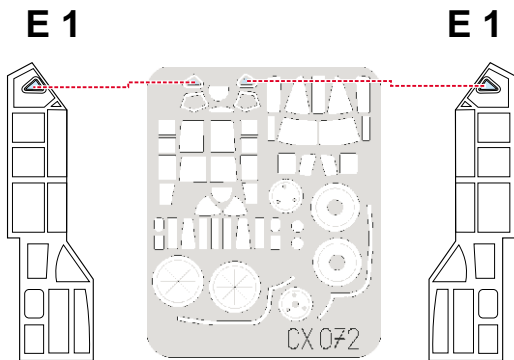

2.)

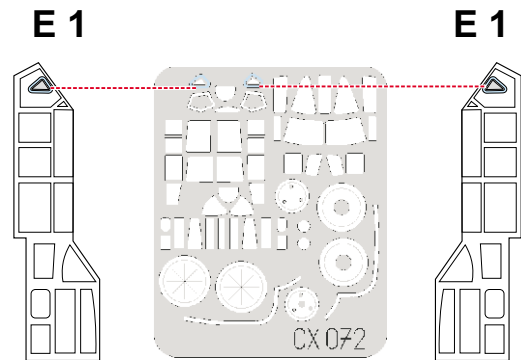

3.)

INTERIOR COLOR

4.)

CAMOUFLAGE COLOR

LIQUID MASK

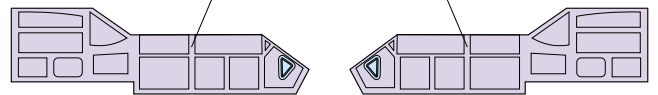

5.)

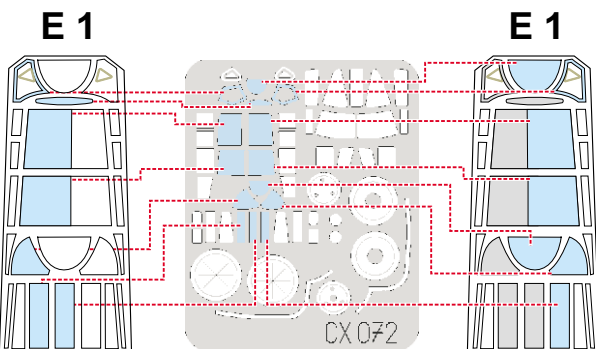

6.)

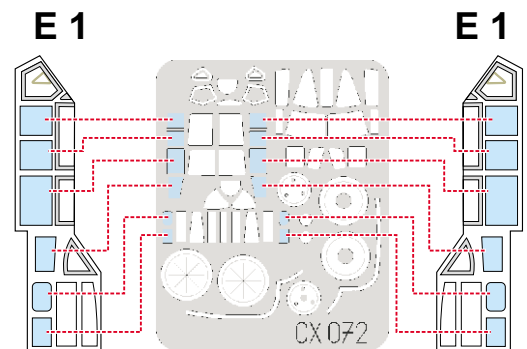

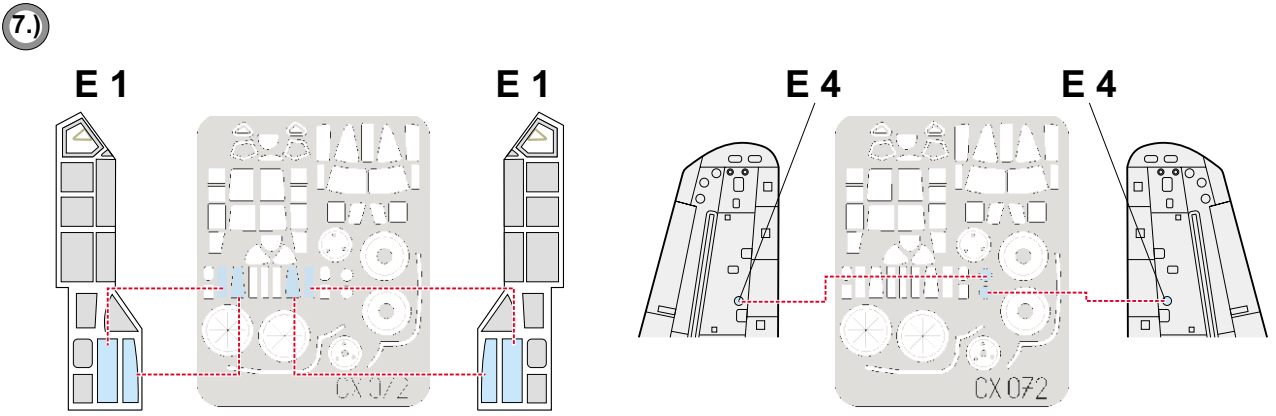

8.)  **INTERIOR COLOR**

9.)  **CAMOUFLAGE COLOR**

LIQUID MASK 

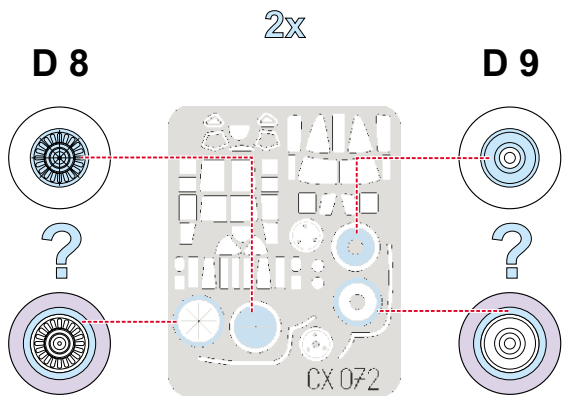
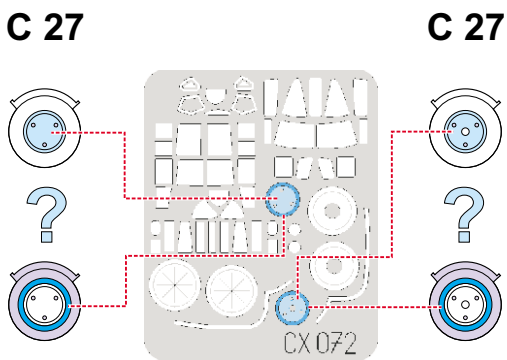
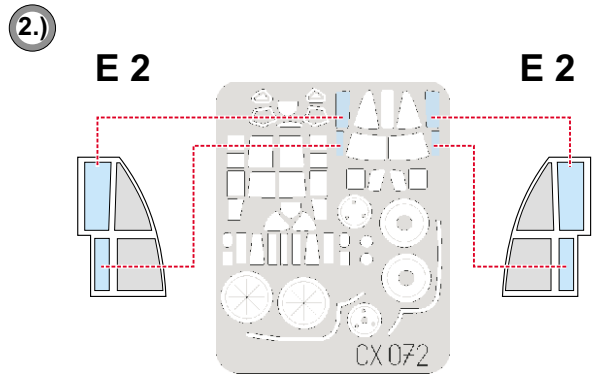
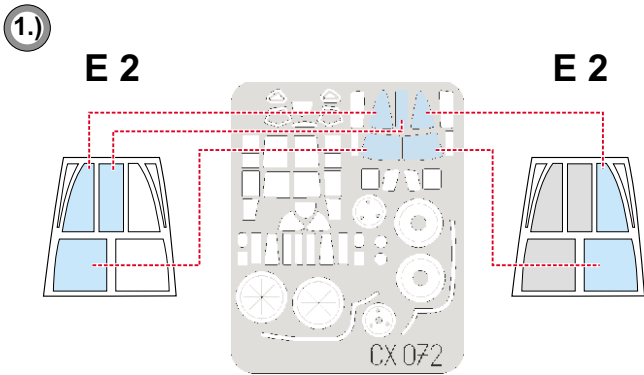
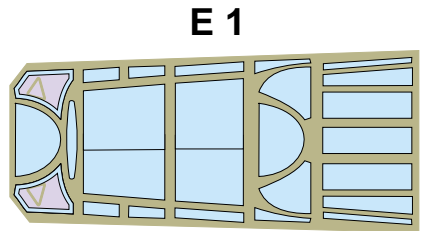

LIQUID MASK 